

"OPTICAL CABLE CORPORATION (OCC)
RESERVES THE RIGHT TO REVISE ANY
AND ALL DESIGN SPECIFICATIONS."

UNCONTROLLED COPY

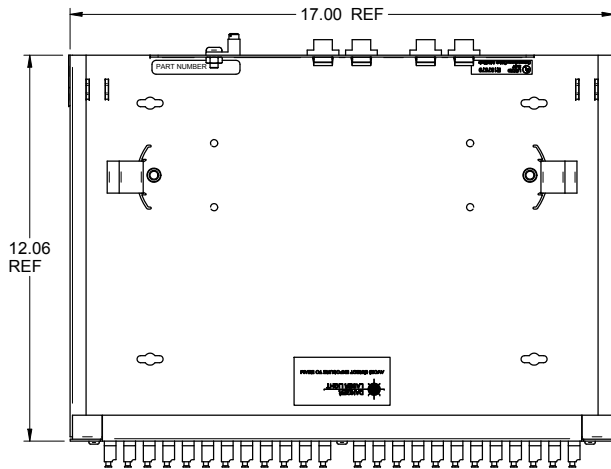

TOP VIEW
(SHOWN WITHOUT COVER)

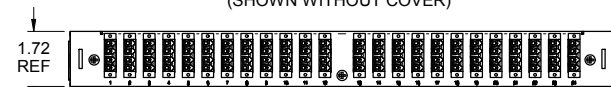

FRONT VIEW
(ADAPTER DUST CAPS PROVIDED)

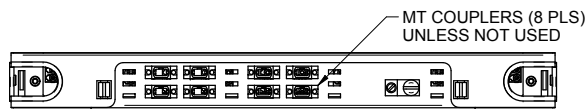

BACK VIEW
(DUST COVERS NOT SHOWN FOR CLARITY)

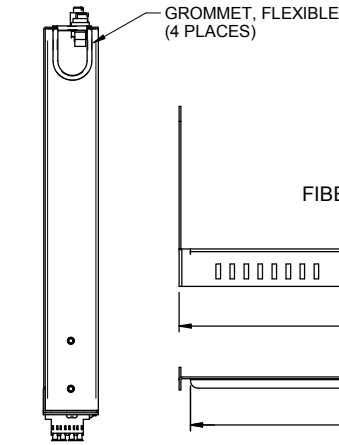

RIGHT SIDE

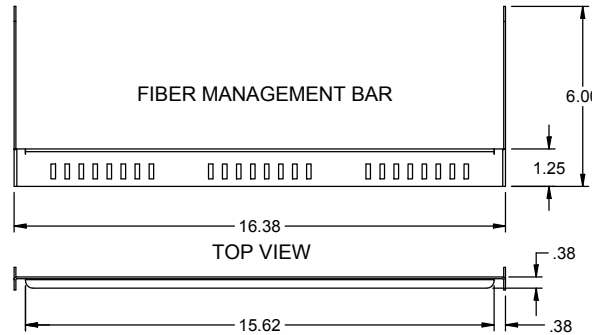

TOP VIEW

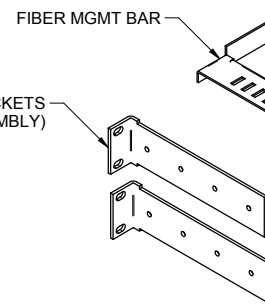

19"/23" MTG BRACKETS
(2 REQ'D PER ASSEMBLY)

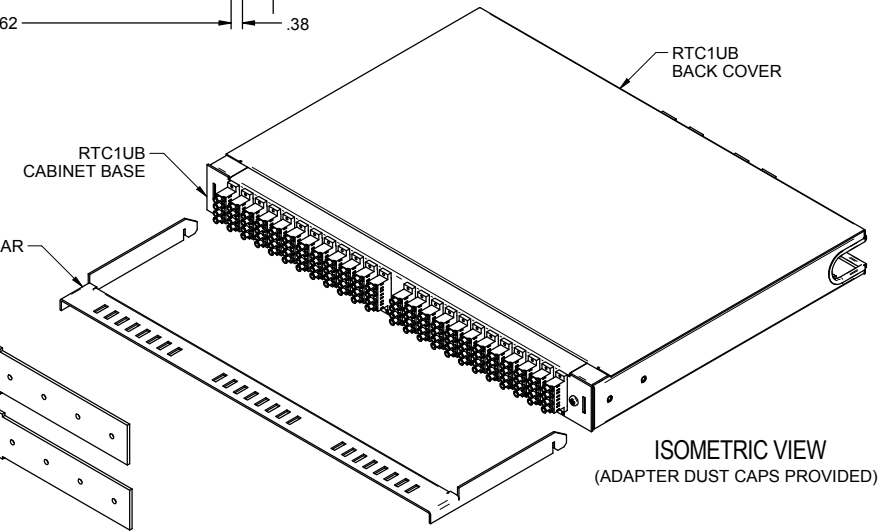

ISOMETRIC VIEW
(ADAPTER DUST CAPS PROVIDED)

SPECIFICATIONS

FEATURES & BENEFITS:

- OPTICAL CABLE CORPORATIONS, RACK MOUNT RTC FIBER TRAY FIBER OPTIC MOUNTING CROSS CONNECT PATCH PANELS PROVIDE FIBER MANAGEMENT, CONNECTIVITY AND DISTRIBUTION FOR 6-96 FIBERS. ACCOMMODATES ALL CROSS CONNECT FUNCTIONS (SPlicing, TERMINATION, AND INTERCONNECTION) FOR OUTSIDE PLANT, BACKBONE, AND BUILDING CABLES.
- ACCOMMODATES SNAP-IN ADAPTERS. RTC FIBER TRAY PORT COUNT IS BASED ON SIMPLEX AND/OR DUPLEX ADAPTERS FOR TERMINATE AND CABLE MANAGEMENT. WELL SUITED TO MULTIMEDIA/MULTI-APPLICATION CABLING ENVIRONMENTS.
- FIBER MANAGEMENT BAR OFFERS ENHANCED CABLE MANAGEMENT. TIE-WRAPPS PROVIDED TO CONTROL CABLING ALONG BAR. BAR IS REMOVABLE FOR INSTALLATION CONVENIENCE.

- PANEL IS RUGGED 16-GAUGE STEEL CONSTRUCTION WITH A DURABLE POWDER COAT FINISH, COLOR BLACK.
- STANDARD PATCH PANEL MOUNTING TO FIT 19" RACK. MOUNTING HARDWARE INCLUDED WITH RTC PANELS.
- ALL PLASTIC COMPONENTS ARE HIGH IMPACT SELF-EXTINGUISHING, UL LISTED RATING 94V-0.

RTC1UB-96QLC	RTC FIBER TRAY, 96 PORT, Quad LC X 24, SM/MM, FBR MGMT, w/o MT
RTC1UB-96QLC/MT	RTC FIBER TRAY, 96 PORT, Quad LC X 24, SM/MM, FBR MGMT, with MT
RTC1UB-96QLCMM	RTC FIBER TRAY, 96 PORT, Quad LC X 24, MM, FIBER MGMT, w/o MT
RTC1UB-QLCMM/MT	RTC FIBER TRAY, 96 PORT, Quad LC X 24, MM, FIBER MGMT, with MT
RTC1UB-96QLCSM	RTC FIBER TRAY, 96 PORT, Quad LC X 24, SM, FIBER MGMT, w/o MT
RTC1UB-96QLCSM/MT	RTC FIBER TRAY, 96 PORT, Quad LC X 24, SM, FIBER MGMT, with MT
OCC PART NUMBER	DESCRIPTION

UNLESS OTHERWISE SPECIFIED THIS DRAWING AND THE DESIGN SHOWN ARE THE PROPERTY OF OPTICAL CABLE CORPORATION AND DIMENSIONS ARE IN INCHES.	
TOLERANCES: FRACTIONS ±1/32	
ANGLES ±1/2°	
3 PLACE DECIMALS ±.005"	
2 PLACE DECIMALS ±.01"	
MATERIAL VARIOUS SEE BILL OF MATERIAL	CHECKED J. HOWE DATE 10/2/06
FINISH SEE NOTES	ENGINEER J. YANIK DATE 6/6/06
	APPROVED J.CALLOWAY DATE 8/4/21
	PREVIOUS DWG
	NEXT DWG

OCC
OPTICAL CABLE CORPORATION

33 Superior Way
Swannanoa, NC 28778
Phone: 828-298-2260
Fax: 828-298-2487
www.occfiber.com

DWG TITLE: CABINET ASSY, RTC1UB, BULKHEAD QLC, FIBER TRAY

SIZE C DWG NO. **C112619** REV J

SCALE: NONE SHEET 1 OF 1

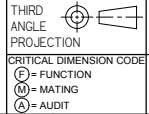

PROPRIETARY AND CONFIDENTIAL