

"OPTICAL CABLE CORPORATION (OCC)
RESERVES THE RIGHT TO REVISE ANY
AND ALL DESIGN SPECIFICATIONS."
UNCONTROLLED COPY

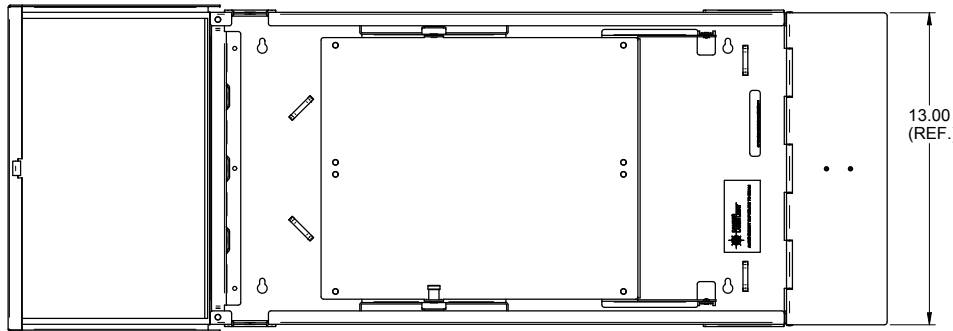

OCC P/N PROWTC-2ISM
TOP VIEW
(FRONT DOOR OPEN)

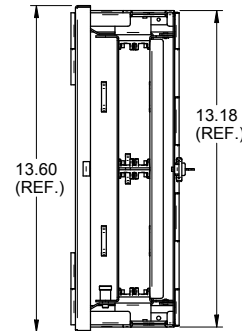

RIGHT SIDE
(OUTER DOOR OPEN)

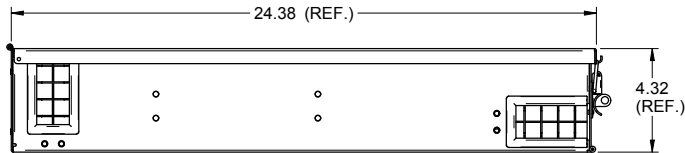

BOTTOM VIEW
(CLOSED)

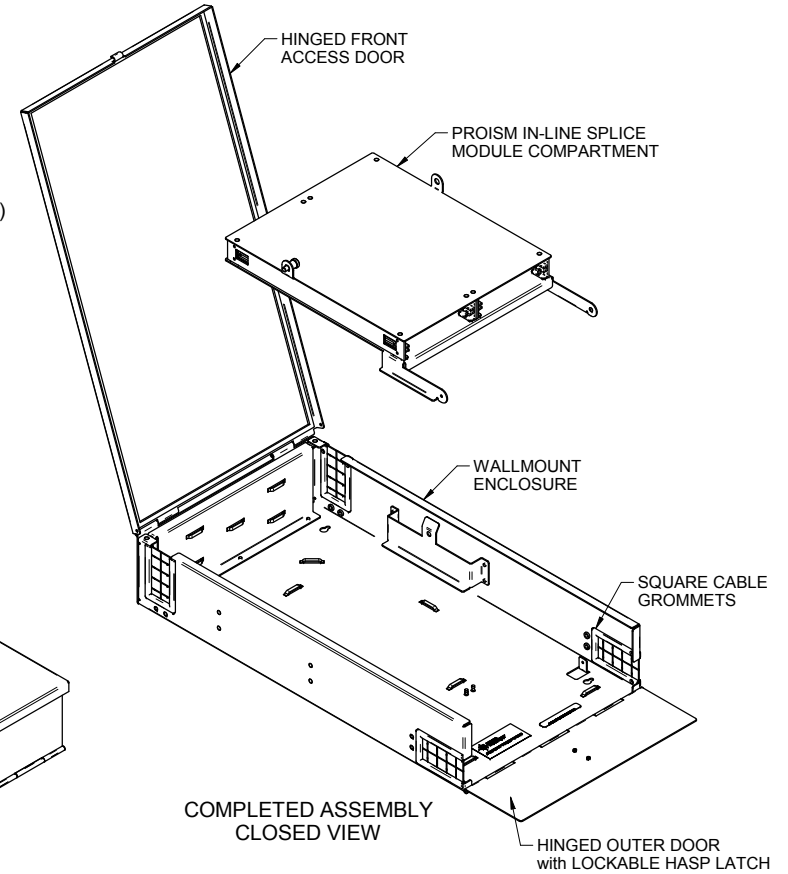

COMPLETED ASSEMBLY
CLOSED VIEW

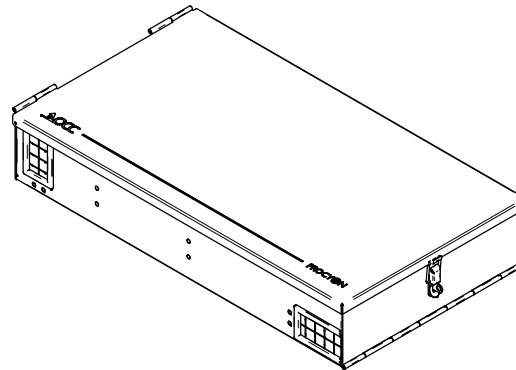

COMPLETED ASSEMBLY
CLOSED VIEW

SPECIFICATIONS

FEATURES & BENEFITS:

- OPTICAL CABLE CORPORATION'S, **PROWTC-2ISM** SERIES FIBER OPTIC CROSS CONNECT ENCLOSURES PROVIDE FIBER MANAGEMENT CONNECTIVITY, AND DISTRIBUTION FOR 6 TO 48 FIBERS. ACCOMMODATES ALL CROSS CONNECT FUNCTIONS (SPLICING, TERMINATION, AND INTERCONNECTION) FOR OUTSIDE PLANT, BACKBONE, AND BUILDING CABLES.
- ACCOMMODATES THE PROISM IN-LINE SPLICE MODULE WITH HD SNAP-IN ADAPTER PLATE. **PROWTC-2ISM** ENCLOSURE PORT COUNT BASED UPON PORT DENSITY OF PROISM IN-LINE SPLICE MODULE (ORDERED SEPARATELY).
- **PROWTC-2ISM** ENCLOSURES PROVIDE INNOVATIVE FIBER ORGANIZATION UTILIZING PROISM IN-LINE SPLICE MODULE COMPARTMENT DESIGNED TO MAINTAIN ORDERLY FIBER MANAGEMENT AND ALLOW FOR GREATER SEGREGATION OF INCOMING FIBER CABLES.
- CABLING GROMMETS PROVIDE RELIABLE CABLE PROTECTION AT ALL CABLE ENTRANCES AND EXITS.
- RUGGED 16-GAUGE STEEL CONSTRUCTION WITH A DURABLE POWDER COAT FINISH. PROWTC-2ISM ENCLOSURE COLOR: BLACK
- HINGED FRONT AND OUTER DOORS PROVIDE LOCKABLE LATCH EXTERIOR WITH EASY FRONT AND INNER ACCESS.
- ALL PLASTIC COMPONENTS ARE HIGH-IMPACT SELF-EXTINGUISHING, UL LISTED RATING 94 V-0.
- PROISM IN-LINE SPLICE MODULE & EXTERNAL STRAIN RELIEF BRACKETS ARE ORDERED SEPARATELY AS AN OPTION FOR **PROWTC-2ISM** ENCLOSURE.

PROWTC-2ISM	CABINET ASSY, WALL MOUNT, 48F, BLACK, PROCYON	
OCC PART NO.	DESCRIPTION	
UNCONTROLLED COPY		
UNLESS OTHERWISE SPECIFIED DIMENSIONS ARE IN INCHES TOLERANCES: FRACTIONS ±1/32" ANGLES ±1/2° 3 PLACE DECIMALS ±.015" 2 PLACE DECIMALS ±.03"	THIS DRAWING AND THE DESIGN SHOWN ARE THE PROPERTY OF OPTICAL CABLE CORPORATION AND MAY NOT BE USED AS THE BASIS FOR MANUFACTURE OR SALE WITHOUT SPECIFIC WRITTEN PERMISSION OF OPTICAL CABLE CORPORATION.	 33 Superior Way Swannanoa, NC 28778 Phone: 828-298-2260 Fax: 828-298-2487 www.occfiber.com
MATERIAL SEE BILL OF MATERIAL	DRAWN D.A.HOLBERT DATE 9/30/14	DWG TITLE CUSTOMER DRAWING, PROWTC-2ISM CABINET ASSY, WALL MOUNT, 48F, PROCYON
FINISH SEE NOTES	CHECKED J.HOWE DATE 1/7/15	SIZE C
	ENGINEER J.YANIK DATE 9/30/14	DWG NO. C112031
	APPROVED CALLOWAY DATE 8/19/22	REV A
	PREVIOUS DWG	SCALE: NONE
	NEXT DWG	SHEET 1 OF 1
	FILENAME C112031A.dft	

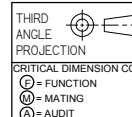

PROPRIETARY AND CONFIDENTIAL